

S-NVD

- ▶ 下穴・センターモミ不要、一発加工で鏡面仕上げ可能
- ▶ $\phi 1 \sim \phi 30$ まで豊富なラインアップ
($\phi 1 \sim \phi 10$ まで0.01mmトビ)

NVドリル

炭素鋼・合金鋼		アルミニウム合金	◎	銅合金	△
鋳鉄	◎	樹脂		真鍮	△
ダクタイル鋳鉄	○	ステンレス			

φ D公差 (●在庫品)

φ 1 ~ φ 2.98	φ 2.99 ~ φ 4.05	φ 4.1 ~ φ 6.05	φ 6.1 ~ φ 10.05	φ 10.1 ~ φ 16
+0.003 0	+0.007 +0.003	+0.008 +0.004	+0.010 +0.005	+0.012 +0.006

φ D公差 (★特定代理店在庫)

φ 1 ~ φ 2.98	φ 3.06 ~ φ 9.94	φ 17 ~ φ 18	φ 19 ~ φ 30
+0.003 0	+0.005 0	+0.012 +0.006	+0.014 +0.007

φ d公差

φ 1 ~ φ 2.98	φ 3	φ 4 ~ φ 5	φ 6 ~ φ 10	φ 11 ~ φ 16	φ 20 ~ φ 30	φ 32
+0.003 0	0 -0.010	0 -0.012	0 -0.015	0 -0.018	0 -0.021	0 -0.025

推奨条件

被削材	切削速度 V (m/min)	送り f (mm/rev)
アルミ	50 ~ 150	0.05 ~ 0.15
鋳鉄	20 ~ 70	0.05 ~ 0.1



TYPE A

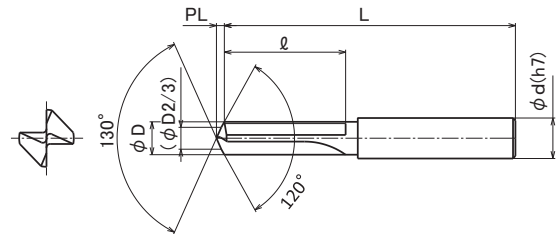

TYPE B (φ 17 ~ V口一付)

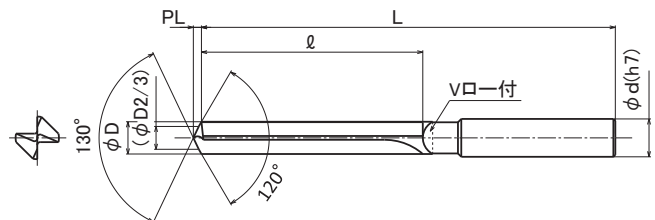

在庫	型番	φD	ℓ	L	PL	φd	TYPE
●	S-NVD0100040	1	10	40	0.3	1	A
★	S-NVD0101040	1.01	10	40	0.3	1.01	A
★	S-NVD0102040	1.02	10	40	0.3	1.02	A
★	S-NVD0103040	1.03	10	40	0.3	1.03	A
★	S-NVD0104040	1.04	10	40	0.3	1.04	A
★	S-NVD0105040	1.05	10	40	0.3	1.05	A
★	S-NVD0106040	1.06	10	40	0.3	1.06	A
★	S-NVD0107040	1.07	10	40	0.3	1.07	A
★	S-NVD0108040	1.08	10	40	0.3	1.08	A
★	S-NVD0109040	1.09	10	40	0.3	1.09	A
●	S-NVD0110040	1.1	10	40	0.3	1.1	A
★	S-NVD0111040	1.11	10	40	0.3	1.11	A
★	S-NVD0112040	1.12	10	40	0.3	1.12	A
★	S-NVD0113040	1.13	10	40	0.3	1.13	A
★	S-NVD0114040	1.14	10	40	0.3	1.14	A
★	S-NVD0115040	1.15	10	40	0.3	1.15	A
★	S-NVD0116040	1.16	10	40	0.3	1.16	A
★	S-NVD0117040	1.17	10	40	0.3	1.17	A
★	S-NVD0118040	1.18	10	40	0.3	1.18	A
★	S-NVD0119040	1.19	10	40	0.3	1.19	A
●	S-NVD0120040	1.2	10	40	0.3	1.2	A
★	S-NVD0121040	1.21	10	40	0.3	1.21	A
★	S-NVD0122040	1.22	10	40	0.3	1.22	A
★	S-NVD0123040	1.23	10	40	0.3	1.23	A
★	S-NVD0124040	1.24	10	40	0.3	1.24	A
★	S-NVD0125040	1.25	10	40	0.3	1.25	A
★	S-NVD0126040	1.26	10	40	0.3	1.26	A
★	S-NVD0127040	1.27	10	40	0.3	1.27	A
★	S-NVD0128040	1.28	10	40	0.3	1.28	A
★	S-NVD0129040	1.29	10	40	0.3	1.29	A
●	S-NVD0130040	1.3	10	40	0.3	1.3	A
★	S-NVD0131040	1.31	10	40	0.3	1.31	A
★	S-NVD0132040	1.32	10	40	0.3	1.32	A
★	S-NVD0133040	1.33	10	40	0.3	1.33	A
★	S-NVD0134040	1.34	10	40	0.3	1.34	A
★	S-NVD0135040	1.35	10	40	0.3	1.35	A
★	S-NVD0136040	1.36	10	40	0.3	1.36	A
★	S-NVD0137040	1.37	10	40	0.3	1.37	A
★	S-NVD0138040	1.38	10	40	0.4	1.38	A
★	S-NVD0139040	1.39	10	40	0.4	1.39	A
●	S-NVD0140040	1.4	10	40	0.4	1.4	A
★	S-NVD0141040	1.41	10	40	0.4	1.41	A
★	S-NVD0142040	1.42	10	40	0.4	1.42	A
★	S-NVD0143040	1.43	10	40	0.4	1.43	A
★	S-NVD0144040	1.44	10	40	0.4	1.44	A
★	S-NVD0145040	1.45	10	40	0.4	1.45	A
★	S-NVD0146040	1.46	10	40	0.4	1.46	A
★	S-NVD0147040	1.47	10	40	0.4	1.47	A
★	S-NVD0148040	1.48	10	40	0.4	1.48	A
★	S-NVD0149040	1.49	10	40	0.4	1.49	A
●	S-NVD0150040	1.5	10	40	0.4	1.5	A
★	S-NVD0151040	1.51	10	40	0.4	1.51	A
★	S-NVD0152040	1.52	10	40	0.4	1.52	A
★	S-NVD0153040	1.53	10	40	0.4	1.53	A

在庫	型番	φ D	ℓ	L	PL	φ d	TYPE
★	S-NVD0154040	1.54	10	40	0.4	1.54	A
★	S-NVD0155040	1.55	10	40	0.4	1.55	A
★	S-NVD0156040	1.56	10	40	0.4	1.56	A
★	S-NVD0157040	1.57	10	40	0.4	1.57	A
★	S-NVD0158040	1.58	10	40	0.4	1.58	A
★	S-NVD0159040	1.59	10	40	0.4	1.59	A
●	S-NVD0160040	1.6	10	40	0.4	1.6	A
★	S-NVD0161040	1.61	10	40	0.4	1.61	A
★	S-NVD0162040	1.62	10	40	0.4	1.62	A
★	S-NVD0163040	1.63	10	40	0.4	1.63	A
★	S-NVD0164040	1.64	10	40	0.4	1.64	A
★	S-NVD0165040	1.65	10	40	0.4	1.65	A
★	S-NVD0166040	1.66	10	40	0.4	1.66	A
★	S-NVD0167040	1.67	10	40	0.4	1.67	A
★	S-NVD0168040	1.68	10	40	0.4	1.68	A
★	S-NVD0169040	1.69	10	40	0.4	1.69	A
●	S-NVD0170040	1.7	10	40	0.4	1.7	A
★	S-NVD0171040	1.71	10	40	0.4	1.71	A
★	S-NVD0172040	1.72	10	40	0.4	1.72	A
★	S-NVD0173040	1.73	10	40	0.4	1.73	A
★	S-NVD0174040	1.74	10	40	0.4	1.74	A
★	S-NVD0175040	1.75	10	40	0.4	1.75	A
★	S-NVD0176040	1.76	10	40	0.4	1.76	A
★	S-NVD0177040	1.77	10	40	0.5	1.77	A
★	S-NVD0178040	1.78	10	40	0.5	1.78	A
★	S-NVD0179040	1.79	10	40	0.5	1.79	A
●	S-NVD0180040	1.8	10	40	0.5	1.8	A
★	S-NVD0181040	1.81	10	40	0.5	1.81	A
★	S-NVD0182040	1.82	10	40	0.5	1.82	A
★	S-NVD0183040	1.83	10	40	0.5	1.83	A
★	S-NVD0184040	1.84	10	40	0.5	1.84	A
★	S-NVD0185040	1.85	10	40	0.5	1.85	A
★	S-NVD0186040	1.86	10	40	0.5	1.86	A
★	S-NVD0187040	1.87	10	40	0.5	1.87	A
★	S-NVD0188040	1.88	10	40	0.5	1.88	A
★	S-NVD0189040	1.89	10	40	0.5	1.89	A
●	S-NVD0190040	1.9	10	40	0.5	1.9	A
★	S-NVD0191040	1.91	10	40	0.5	1.91	A
★	S-NVD0192040	1.92	10	40	0.5	1.92	A
★	S-NVD0193040	1.93	10	40	0.5	1.93	A
★	S-NVD0194040	1.94	10	40	0.5	1.94	A
★	S-NVD0195040	1.95	10	40	0.5	1.95	A
★	S-NVD0196040	1.96	10	40	0.5	1.96	A
★	S-NVD0197040	1.97	10	40	0.5	1.97	A
★	S-NVD0198040	1.98	10	40	0.5	1.98	A
★	S-NVD0199040	1.99	10	40	0.5	1.99	A
●	S-NVD0200050	2	15	50	0.5	2	A
★	S-NVD0201050	2.01	15	50	0.5	2.01	A
★	S-NVD0202050	2.02	15	50	0.5	2.02	A
★	S-NVD0203050	2.03	15	50	0.5	2.03	A
★	S-NVD0204050	2.04	15	50	0.5	2.04	A
★	S-NVD0205050	2.05	15	50	0.5	2.05	A
★	S-NVD0206050	2.06	15	50	0.5	2.06	A
★	S-NVD0207050	2.07	15	50	0.5	2.07	A
★	S-NVD0208050	2.08	15	50	0.5	2.08	A
★	S-NVD0209050	2.09	15	50	0.5	2.09	A
●	S-NVD0210050	2.1	15	50	0.5	2.1	A
★	S-NVD0211050	2.11	15	50	0.5	2.11	A

●：在庫品 ★：特定代理店在庫 ○：受注生産品

穴あけ加工

Nマドリル
S-NVD

単位：mm

在庫	型番	φ D	φ	L	PL	φ d	TYPE
★	S-NVD0212050	2.12	15	50	0.5	2.12	A
★	S-NVD0213050	2.13	15	50	0.5	2.13	A
★	S-NVD0214050	2.14	15	50	0.5	2.14	A
★	S-NVD0215050	2.15	15	50	0.5	2.15	A
★	S-NVD0216050	2.16	15	50	0.5	2.16	A
★	S-NVD0217050	2.17	15	50	0.6	2.17	A
★	S-NVD0218050	2.18	15	50	0.6	2.18	A
★	S-NVD0219050	2.19	15	50	0.6	2.19	A
●	S-NVD0220050	2.2	15	50	0.6	2.2	A
★	S-NVD0221050	2.21	15	50	0.6	2.21	A
★	S-NVD0222050	2.22	15	50	0.6	2.22	A
★	S-NVD0223050	2.23	15	50	0.6	2.23	A
★	S-NVD0224050	2.24	15	50	0.6	2.24	A
★	S-NVD0225050	2.25	15	50	0.6	2.25	A
★	S-NVD0226050	2.26	15	50	0.6	2.26	A
★	S-NVD0227050	2.27	15	50	0.6	2.27	A
★	S-NVD0228050	2.28	15	50	0.6	2.28	A
★	S-NVD0229050	2.29	15	50	0.6	2.29	A
●	S-NVD0230050	2.3	15	50	0.6	2.3	A
★	S-NVD0231050	2.31	15	50	0.6	2.31	A
★	S-NVD0232050	2.32	15	50	0.6	2.32	A
★	S-NVD0233050	2.33	15	50	0.6	2.33	A
★	S-NVD0234050	2.34	15	50	0.6	2.34	A
★	S-NVD0235050	2.35	15	50	0.6	2.35	A
★	S-NVD0236050	2.36	15	50	0.6	2.36	A
★	S-NVD0237050	2.37	15	50	0.6	2.37	A
★	S-NVD0238050	2.38	15	50	0.6	2.38	A
★	S-NVD0239050	2.39	15	50	0.6	2.39	A
●	S-NVD0240050	2.4	15	50	0.6	2.4	A
★	S-NVD0241050	2.41	15	50	0.6	2.41	A
★	S-NVD0242050	2.42	15	50	0.6	2.42	A
★	S-NVD0243050	2.43	15	50	0.6	2.43	A
★	S-NVD0244050	2.44	15	50	0.6	2.44	A
★	S-NVD0245050	2.45	15	50	0.6	2.45	A
★	S-NVD0246050	2.46	15	50	0.6	2.46	A
★	S-NVD0247050	2.47	15	50	0.6	2.47	A
★	S-NVD0248050	2.48	15	50	0.6	2.48	A
★	S-NVD0249050	2.49	15	50	0.6	2.49	A
●	S-NVD0250050	2.5	15	50	0.6	2.5	A
★	S-NVD0251050	2.51	15	50	0.6	2.51	A
★	S-NVD0252050	2.52	15	50	0.6	2.52	A
★	S-NVD0253050	2.53	15	50	0.6	2.53	A
★	S-NVD0254050	2.54	15	50	0.6	2.54	A
★	S-NVD0255050	2.55	15	50	0.6	2.55	A
★	S-NVD0256050	2.56	15	50	0.6	2.56	A
★	S-NVD0257050	2.57	15	50	0.7	2.57	A
★	S-NVD0258050	2.58	15	50	0.7	2.58	A
★	S-NVD0259050	2.59	15	50	0.7	2.59	A
●	S-NVD0260060	2.6	20	60	0.7	2.6	A
★	S-NVD0261060	2.61	20	60	0.7	2.61	A
★	S-NVD0262060	2.62	20	60	0.7	2.62	A
★	S-NVD0263060	2.63	20	60	0.7	2.63	A
★	S-NVD0264060	2.64	20	60	0.7	2.64	A
★	S-NVD0265060	2.65	20	60	0.7	2.65	A
★	S-NVD0266060	2.66	20	60	0.7	2.66	A
★	S-NVD0267060	2.67	20	60	0.7	2.67	A
★	S-NVD0268060	2.68	20	60	0.7	2.68	A
★	S-NVD0269060	2.69	20	60	0.7	2.69	A

●：在庫品 ★：特定代理店在庫 ○：受注生産品

在庫	型番	φ D	ℓ	L	PL	φ d	TYPE
●	S-NVD0270060	2.7	20	60	0.7	2.7	A
★	S-NVD0271060	2.71	20	60	0.7	2.71	A
★	S-NVD0272060	2.72	20	60	0.7	2.72	A
★	S-NVD0273060	2.73	20	60	0.7	2.73	A
★	S-NVD0274060	2.74	20	60	0.7	2.74	A
★	S-NVD0275060	2.75	20	60	0.7	2.75	A
★	S-NVD0276060	2.76	20	60	0.7	2.76	A
★	S-NVD0277060	2.77	20	60	0.7	2.77	A
★	S-NVD0278060	2.78	20	60	0.7	2.78	A
★	S-NVD0279060	2.79	20	60	0.7	2.79	A
●	S-NVD0280060	2.8	20	60	0.7	2.8	A
★	S-NVD0281060	2.81	20	60	0.7	2.81	A
★	S-NVD0282060	2.82	20	60	0.7	2.82	A
★	S-NVD0283060	2.83	20	60	0.7	2.83	A
★	S-NVD0284060	2.84	20	60	0.7	2.84	A
★	S-NVD0285060	2.85	20	60	0.7	2.85	A
★	S-NVD0286060	2.86	20	60	0.7	2.86	A
★	S-NVD0287060	2.87	20	60	0.7	2.87	A
★	S-NVD0288060	2.88	20	60	0.7	2.88	A
★	S-NVD0289060	2.89	20	60	0.7	2.89	A
●	S-NVD0290060	2.9	20	60	0.7	2.9	A
★	S-NVD0291060	2.91	20	60	0.7	2.91	A
★	S-NVD0292060	2.92	20	60	0.7	2.92	A
★	S-NVD0293060	2.93	20	60	0.7	2.93	A
★	S-NVD0294060	2.94	20	60	0.7	2.94	A
★	S-NVD0295060	2.95	20	60	0.7	2.95	A
★	S-NVD0296060	2.96	20	60	0.7	2.96	A
★	S-NVD0297060	2.97	20	60	0.8	2.97	A
★	S-NVD0298060	2.98	20	60	0.8	2.98	A
●	S-NVD0299080	2.99	50	80	0.8	3	A
●	S-NVD0300080	3	50	80	0.8	3	A
●	S-NVD0301080	3.01	50	80	0.8	3	A
●	S-NVD0302080	3.02	50	80	0.8	3	A
●	S-NVD0303080	3.03	50	80	0.8	3	A
●	S-NVD0304080	3.04	50	80	0.8	3	A
●	S-NVD0305080	3.05	50	80	0.8	3	A
★	S-NVD0306080	3.06	50	80	0.8	3	A
★	S-NVD0307080	3.07	50	80	0.8	3	A
★	S-NVD0308080	3.08	50	80	0.8	3	A
★	S-NVD0309080	3.09	50	80	0.8	3	A
●	S-NVD0310080	3.1	50	80	0.8	3	A
★	S-NVD0311080	3.11	50	80	0.8	3	A
★	S-NVD0312080	3.12	50	80	0.8	3	A
★	S-NVD0313080	3.13	50	80	0.8	3	A
★	S-NVD0314080	3.14	50	80	0.8	3	A
★	S-NVD0315080	3.15	50	80	0.8	3	A
★	S-NVD0316080	3.16	50	80	0.8	3	A
★	S-NVD0317080	3.17	50	80	0.8	3	A
★	S-NVD0318080	3.18	50	80	0.8	3	A
★	S-NVD0319080	3.19	50	80	0.8	3	A
●	S-NVD0320080	3.2	50	80	0.8	3	A
★	S-NVD0321080	3.21	50	80	0.8	3	A
★	S-NVD0322080	3.22	50	80	0.8	3	A
★	S-NVD0323080	3.23	50	80	0.8	3	A
★	S-NVD0324080	3.24	50	80	0.8	3	A
★	S-NVD0325080	3.25	50	80	0.8	3	A
★	S-NVD0326080	3.26	50	80	0.8	3	A
★	S-NVD0327080	3.27	50	80	0.8	3	A

●：在庫品 ★：特定代理店在庫 ○：受注生産品

穴あけ加工

Nマドリル
S-NVD

単位：mm

在庫	型番	φ D	φ	L	PL	φ d	TYPE
★	S-NVD0328080	3.28	50	80	0.8	3	A
★	S-NVD0329080	3.29	50	80	0.8	3	A
●	S-NVD0330080	3.3	50	80	0.8	3	A
★	S-NVD0331080	3.31	50	80	0.8	3	A
★	S-NVD0332080	3.32	50	80	0.8	3	A
★	S-NVD0333080	3.33	50	80	0.8	3	A
★	S-NVD0334080	3.34	50	80	0.8	3	A
★	S-NVD0335080	3.35	50	80	0.8	3	A
★	S-NVD0336080	3.36	50	80	0.9	3	A
★	S-NVD0337080	3.37	50	80	0.9	3	A
★	S-NVD0338080	3.38	50	80	0.9	3	A
★	S-NVD0339080	3.39	50	80	0.9	3	A
●	S-NVD0340080	3.4	50	80	0.9	3	A
★	S-NVD0341080	3.41	50	80	0.9	3	A
★	S-NVD0342080	3.42	50	80	0.9	3	A
★	S-NVD0343080	3.43	50	80	0.9	3	A
★	S-NVD0344080	3.44	50	80	0.9	3	A
★	S-NVD0345080	3.45	50	80	0.9	3	A
★	S-NVD0346080	3.46	50	80	0.9	3	A
★	S-NVD0347080	3.47	50	80	0.9	3	A
★	S-NVD0348080	3.48	50	80	0.9	3	A
★	S-NVD0349080	3.49	50	80	0.9	3	A
●	S-NVD0350080	3.5	50	80	0.9	3	A
★	S-NVD0351080	3.51	50	80	0.9	3	A
★	S-NVD0352080	3.52	50	80	0.9	3	A
★	S-NVD0353080	3.53	50	80	0.9	3	A
★	S-NVD0354080	3.54	50	80	0.9	3	A
★	S-NVD0355080	3.55	50	80	0.9	3	A
★	S-NVD0356080	3.56	50	80	0.9	3	A
★	S-NVD0357080	3.57	50	80	0.9	3	A
★	S-NVD0358080	3.58	50	80	0.9	3	A
★	S-NVD0359080	3.59	50	80	0.9	3	A
●	S-NVD0360080	3.6	50	80	0.9	4	A
★	S-NVD0361080	3.61	50	80	0.9	4	A
★	S-NVD0362080	3.62	50	80	0.9	4	A
★	S-NVD0363080	3.63	50	80	0.9	4	A
★	S-NVD0364080	3.64	50	80	0.9	4	A
★	S-NVD0365080	3.65	50	80	0.9	4	A
★	S-NVD0366080	3.66	50	80	0.9	4	A
★	S-NVD0367080	3.67	50	80	0.9	4	A
★	S-NVD0368080	3.68	50	80	0.9	4	A
★	S-NVD0369080	3.69	50	80	0.9	4	A
●	S-NVD0370080	3.7	50	80	0.9	4	A
★	S-NVD0371080	3.71	50	80	0.9	4	A
★	S-NVD0372080	3.72	50	80	0.9	4	A
★	S-NVD0373080	3.73	50	80	0.9	4	A
★	S-NVD0374080	3.74	50	80	0.9	4	A
★	S-NVD0375080	3.75	50	80	0.9	4	A
★	S-NVD0376080	3.76	50	80	1	4	A
★	S-NVD0377080	3.77	50	80	1	4	A
★	S-NVD0378080	3.78	50	80	1	4	A
★	S-NVD0379080	3.79	50	80	1	4	A
●	S-NVD0380080	3.8	50	80	1	4	A
★	S-NVD0381080	3.81	50	80	1	4	A
★	S-NVD0382080	3.82	50	80	1	4	A
★	S-NVD0383080	3.83	50	80	1	4	A
★	S-NVD0384080	3.84	50	80	1	4	A
★	S-NVD0385080	3.85	50	80	1	4	A

●：在庫品 ★：特定代理店在庫 ○：受注生産品

穴あけ加工

NVD
S-NVD

在庫	型番	φ D	ℓ	L	PL	φ d	TYPE
★	S-NVD0386080	3.86	50	80	1	4	A
★	S-NVD0387080	3.87	50	80	1	4	A
★	S-NVD0388080	3.88	50	80	1	4	A
★	S-NVD0389080	3.89	50	80	1	4	A
●	S-NVD0390080	3.9	50	80	1	4	A
★	S-NVD0391080	3.91	50	80	1	4	A
★	S-NVD0392080	3.92	50	80	1	4	A
★	S-NVD0393080	3.93	50	80	1	4	A
★	S-NVD0394080	3.94	50	80	1	4	A
●	S-NVD0395080	3.95	50	80	1	4	A
●	S-NVD0396080	3.96	50	80	1	4	A
●	S-NVD0397080	3.97	50	80	1	4	A
●	S-NVD0398080	3.98	50	80	1	4	A
●	S-NVD0399080	3.99	50	80	1	4	A
●	S-NVD0400080	4	50	80	1	4	A
●	S-NVD0401080	4.01	50	80	1	4	A
●	S-NVD0402080	4.02	50	80	1	4	A
●	S-NVD0403080	4.03	50	80	1	4	A
●	S-NVD0404080	4.04	50	80	1	4	A
●	S-NVD0405080	4.05	50	80	1	4	A
★	S-NVD0406080	4.06	50	80	1	4	A
★	S-NVD0407080	4.07	50	80	1	4	A
★	S-NVD0408080	4.08	50	80	1	4	A
★	S-NVD0409080	4.09	50	80	1	4	A
●	S-NVD0410080	4.1	50	80	1	4	A
★	S-NVD0411080	4.11	50	80	1	4	A
★	S-NVD0412080	4.12	50	80	1	4	A
★	S-NVD0413080	4.13	50	80	1	4	A
★	S-NVD0414080	4.14	50	80	1	4	A
★	S-NVD0415080	4.15	50	80	1	4	A
★	S-NVD0416080	4.16	50	80	1.1	4	A
★	S-NVD0417080	4.17	50	80	1.1	4	A
★	S-NVD0418080	4.18	50	80	1.1	4	A
★	S-NVD0419080	4.19	50	80	1.1	4	A
●	S-NVD0420080	4.2	50	80	1.1	4	A
★	S-NVD0421080	4.21	50	80	1.1	4	A
★	S-NVD0422080	4.22	50	80	1.1	4	A
★	S-NVD0423080	4.23	50	80	1.1	4	A
★	S-NVD0424080	4.24	50	80	1.1	4	A
★	S-NVD0425080	4.25	50	80	1.1	4	A
★	S-NVD0426080	4.26	50	80	1.1	4	A
★	S-NVD0427080	4.27	50	80	1.1	4	A
★	S-NVD0428080	4.28	50	80	1.1	4	A
★	S-NVD0429080	4.29	50	80	1.1	4	A
●	S-NVD0430080	4.3	50	80	1.1	4	A
★	S-NVD0431080	4.31	50	80	1.1	4	A
★	S-NVD0432080	4.32	50	80	1.1	4	A
★	S-NVD0433080	4.33	50	80	1.1	4	A
★	S-NVD0434080	4.34	50	80	1.1	4	A
★	S-NVD0435080	4.35	50	80	1.1	4	A
★	S-NVD0436080	4.36	50	80	1.1	4	A
★	S-NVD0437080	4.37	50	80	1.1	4	A
★	S-NVD0438080	4.38	50	80	1.1	4	A
★	S-NVD0439080	4.39	50	80	1.1	4	A
●	S-NVD0440080	4.4	50	80	1.1	4	A
★	S-NVD0441080	4.41	50	80	1.1	4	A
★	S-NVD0442080	4.42	50	80	1.1	4	A
★	S-NVD0443080	4.43	50	80	1.1	4	A

● : 在庫品 ★ : 特定代理店在庫 ○ : 受注生産品

穴あけ加工

Nマドリル
S-NVD

単位：mm

在庫	型番	φ D	ℓ	L	PL	φ d	TYPE
★	S-NVD0444080	4.44	50	80	1.1	4	A
★	S-NVD0445080	4.45	50	80	1.1	4	A
★	S-NVD0446080	4.46	50	80	1.1	4	A
★	S-NVD0447080	4.47	50	80	1.1	4	A
★	S-NVD0448080	4.48	50	80	1.1	4	A
★	S-NVD0449080	4.49	50	80	1.1	4	A
●	S-NVD0450080	4.5	50	80	1.1	4	A
★	S-NVD0451080	4.51	50	80	1.1	4	A
★	S-NVD0452080	4.52	50	80	1.1	4	A
★	S-NVD0453080	4.53	50	80	1.1	4	A
★	S-NVD0454080	4.54	50	80	1.1	4	A
★	S-NVD0455080	4.55	50	80	1.2	4	A
★	S-NVD0456080	4.56	50	80	1.2	4	A
★	S-NVD0457080	4.57	50	80	1.2	4	A
★	S-NVD0458080	4.58	50	80	1.2	4	A
★	S-NVD0459080	4.59	50	80	1.2	4	A
●	S-NVD0460080	4.6	50	80	1.2	5	A
★	S-NVD0461080	4.61	50	80	1.2	5	A
★	S-NVD0462080	4.62	50	80	1.2	5	A
★	S-NVD0463080	4.63	50	80	1.2	5	A
★	S-NVD0464080	4.64	50	80	1.2	5	A
★	S-NVD0465080	4.65	50	80	1.2	5	A
★	S-NVD0466080	4.66	50	80	1.2	5	A
★	S-NVD0467080	4.67	50	80	1.2	5	A
★	S-NVD0468080	4.68	50	80	1.2	5	A
★	S-NVD0469080	4.69	50	80	1.2	5	A
●	S-NVD0470080	4.7	50	80	1.2	5	A
★	S-NVD0471080	4.71	50	80	1.2	5	A
★	S-NVD0472080	4.72	50	80	1.2	5	A
★	S-NVD0473080	4.73	50	80	1.2	5	A
★	S-NVD0474080	4.74	50	80	1.2	5	A
★	S-NVD0475080	4.75	50	80	1.2	5	A
★	S-NVD0476080	4.76	50	80	1.2	5	A
★	S-NVD0477080	4.77	50	80	1.2	5	A
★	S-NVD0478080	4.78	50	80	1.2	5	A
★	S-NVD0479080	4.79	50	80	1.2	5	A
●	S-NVD0480080	4.8	50	80	1.2	5	A
★	S-NVD0481080	4.81	50	80	1.2	5	A
★	S-NVD0482080	4.82	50	80	1.2	5	A
★	S-NVD0483080	4.83	50	80	1.2	5	A
★	S-NVD0484080	4.84	50	80	1.2	5	A
★	S-NVD0485080	4.85	50	80	1.2	5	A
★	S-NVD0486080	4.86	50	80	1.2	5	A
★	S-NVD0487080	4.87	50	80	1.2	5	A
★	S-NVD0488080	4.88	50	80	1.2	5	A
★	S-NVD0489080	4.89	50	80	1.2	5	A
●	S-NVD0490080	4.9	50	80	1.2	5	A
★	S-NVD0491080	4.91	50	80	1.2	5	A
★	S-NVD0492080	4.92	50	80	1.2	5	A
★	S-NVD0493080	4.93	50	80	1.2	5	A
★	S-NVD0494080	4.94	50	80	1.2	5	A
●	S-NVD0495080	4.95	50	80	1.3	5	A
●	S-NVD0496080	4.96	50	80	1.3	5	A
●	S-NVD0497080	4.97	50	80	1.3	5	A
●	S-NVD0498080	4.98	50	80	1.3	5	A
●	S-NVD0499080	4.99	50	80	1.3	5	A
●	S-NVD0500080	5	50	80	1.3	5	A
●	S-NVD0501080	5.01	50	80	1.3	5	A

●：在庫品 ★：特定代理店在庫 ○：受注生産品

在庫	型番	φ D	φ	L	PL	φ d	TYPE
●	S-NVD0502080	5.02	50	80	1.3	5	A
●	S-NVD0503080	5.03	50	80	1.3	5	A
●	S-NVD0504080	5.04	50	80	1.3	5	A
●	S-NVD0505080	5.05	50	80	1.3	5	A
★	S-NVD0506080	5.06	50	80	1.3	5	A
★	S-NVD0507080	5.07	50	80	1.3	5	A
★	S-NVD0508080	5.08	50	80	1.3	5	A
★	S-NVD0509080	5.09	50	80	1.3	5	A
●	S-NVD0510080	5.1	50	80	1.3	5	A
★	S-NVD0511080	5.11	50	80	1.3	5	A
★	S-NVD0512080	5.12	50	80	1.3	5	A
★	S-NVD0513080	5.13	50	80	1.3	5	A
★	S-NVD0514080	5.14	50	80	1.3	5	A
★	S-NVD0515080	5.15	50	80	1.3	5	A
★	S-NVD0516080	5.16	50	80	1.3	5	A
★	S-NVD0517080	5.17	50	80	1.3	5	A
★	S-NVD0518080	5.18	50	80	1.3	5	A
★	S-NVD0519080	5.19	50	80	1.3	5	A
●	S-NVD0520080	5.2	50	80	1.3	5	A
★	S-NVD0521080	5.21	50	80	1.3	5	A
★	S-NVD0522080	5.22	50	80	1.3	5	A
★	S-NVD0523080	5.23	50	80	1.3	5	A
★	S-NVD0524080	5.24	50	80	1.3	5	A
★	S-NVD0525080	5.25	50	80	1.3	5	A
★	S-NVD0526080	5.26	50	80	1.3	5	A
★	S-NVD0527080	5.27	50	80	1.3	5	A
★	S-NVD0528080	5.28	50	80	1.3	5	A
★	S-NVD0529080	5.29	50	80	1.3	5	A
●	S-NVD0530080	5.3	50	80	1.3	5	A
★	S-NVD0531080	5.31	50	80	1.3	5	A
★	S-NVD0532080	5.32	50	80	1.3	5	A
★	S-NVD0533080	5.33	50	80	1.3	5	A
★	S-NVD0534080	5.34	50	80	1.3	5	A
★	S-NVD0535080	5.35	50	80	1.4	5	A
★	S-NVD0536080	5.36	50	80	1.4	5	A
★	S-NVD0537080	5.37	50	80	1.4	5	A
★	S-NVD0538080	5.38	50	80	1.4	5	A
★	S-NVD0539080	5.39	50	80	1.4	5	A
●	S-NVD0540080	5.4	50	80	1.4	5	A
★	S-NVD0541080	5.41	50	80	1.4	5	A
★	S-NVD0542080	5.42	50	80	1.4	5	A
★	S-NVD0543080	5.43	50	80	1.4	5	A
★	S-NVD0544080	5.44	50	80	1.4	5	A
★	S-NVD0545080	5.45	50	80	1.4	5	A
★	S-NVD0546080	5.46	50	80	1.4	5	A
★	S-NVD0547080	5.47	50	80	1.4	5	A
★	S-NVD0548080	5.48	50	80	1.4	5	A
★	S-NVD0549080	5.49	50	80	1.4	5	A
●	S-NVD0550080	5.5	50	80	1.4	5	A
★	S-NVD0551080	5.51	50	80	1.4	5	A
★	S-NVD0552080	5.52	50	80	1.4	5	A
★	S-NVD0553080	5.53	50	80	1.4	5	A
★	S-NVD0554080	5.54	50	80	1.4	5	A
★	S-NVD0555080	5.55	50	80	1.4	5	A
★	S-NVD0556080	5.56	50	80	1.4	5	A
★	S-NVD0557080	5.57	50	80	1.4	5	A
★	S-NVD0558080	5.58	50	80	1.4	5	A
★	S-NVD0559080	5.59	50	80	1.4	5	A

● : 在庫品 ★ : 特定代理店在庫 ○ : 受注生産品

穴あけ加工

NVD
S-NVD

単位：mm

在庫	型番	φ D	φ	L	PL	φ d	TYPE
●	S-NVD0560100	5.6	60	100	1.4	6	A
★	S-NVD0561100	5.61	60	100	1.4	6	A
★	S-NVD0562100	5.62	60	100	1.4	6	A
★	S-NVD0563100	5.63	60	100	1.4	6	A
★	S-NVD0564100	5.64	60	100	1.4	6	A
★	S-NVD0565100	5.65	60	100	1.4	6	A
★	S-NVD0566100	5.66	60	100	1.4	6	A
★	S-NVD0567100	5.67	60	100	1.4	6	A
★	S-NVD0568100	5.68	60	100	1.4	6	A
★	S-NVD0569100	5.69	60	100	1.4	6	A
●	S-NVD0570100	5.7	60	100	1.4	6	A
★	S-NVD0571100	5.71	60	100	1.4	6	A
★	S-NVD0572100	5.72	60	100	1.4	6	A
★	S-NVD0573100	5.73	60	100	1.4	6	A
★	S-NVD0574100	5.74	60	100	1.4	6	A
★	S-NVD0575100	5.75	60	100	1.5	6	A
★	S-NVD0576100	5.76	60	100	1.5	6	A
★	S-NVD0577100	5.77	60	100	1.5	6	A
★	S-NVD0578100	5.78	60	100	1.5	6	A
★	S-NVD0579100	5.79	60	100	1.5	6	A
●	S-NVD0580100	5.8	60	100	1.5	6	A
★	S-NVD0581100	5.81	60	100	1.5	6	A
★	S-NVD0582100	5.82	60	100	1.5	6	A
★	S-NVD0583100	5.83	60	100	1.5	6	A
★	S-NVD0584100	5.84	60	100	1.5	6	A
★	S-NVD0585100	5.85	60	100	1.5	6	A
★	S-NVD0586100	5.86	60	100	1.5	6	A
★	S-NVD0587100	5.87	60	100	1.5	6	A
★	S-NVD0588100	5.88	60	100	1.5	6	A
★	S-NVD0589100	5.89	60	100	1.5	6	A
●	S-NVD0590100	5.9	60	100	1.5	6	A
★	S-NVD0591100	5.91	60	100	1.5	6	A
★	S-NVD0592100	5.92	60	100	1.5	6	A
★	S-NVD0593100	5.93	60	100	1.5	6	A
★	S-NVD0594100	5.94	60	100	1.5	6	A
●	S-NVD0595100	5.95	60	100	1.5	6	A
●	S-NVD0596100	5.96	60	100	1.5	6	A
●	S-NVD0597100	5.97	60	100	1.5	6	A
●	S-NVD0598100	5.98	60	100	1.5	6	A
●	S-NVD0599100	5.99	60	100	1.5	6	A
●	S-NVD0600100	6	60	100	1.5	6	A
●	S-NVD0601100	6.01	60	100	1.5	6	A
●	S-NVD0602100	6.02	60	100	1.5	6	A
●	S-NVD0603100	6.03	60	100	1.5	6	A
●	S-NVD0604100	6.04	60	100	1.5	6	A
●	S-NVD0605100	6.05	60	100	1.5	6	A
★	S-NVD0606100	6.06	60	100	1.5	6	A
★	S-NVD0607100	6.07	60	100	1.5	6	A
★	S-NVD0608100	6.08	60	100	1.5	6	A
★	S-NVD0609100	6.09	60	100	1.5	6	A
●	S-NVD0610100	6.1	60	100	1.5	6	A
★	S-NVD0611100	6.11	60	100	1.5	6	A
★	S-NVD0612100	6.12	60	100	1.5	6	A
★	S-NVD0613100	6.13	60	100	1.5	6	A
★	S-NVD0614100	6.14	60	100	1.6	6	A
★	S-NVD0615100	6.15	60	100	1.6	6	A
★	S-NVD0616100	6.16	60	100	1.6	6	A
★	S-NVD0617100	6.17	60	100	1.6	6	A

穴あけ加工

NVD
S-NVD

●：在庫品 ★：特定代理店在庫 ○：受注生産品

在庫	型番	φD	ℓ	L	PL	φd	TYPE
★	S-NVD0618100	6.18	60	100	1.6	6	A
★	S-NVD0619100	6.19	60	100	1.6	6	A
●	S-NVD0620100	6.2	60	100	1.6	6	A
★	S-NVD0621100	6.21	60	100	1.6	6	A
★	S-NVD0622100	6.22	60	100	1.6	6	A
★	S-NVD0623100	6.23	60	100	1.6	6	A
★	S-NVD0624100	6.24	60	100	1.6	6	A
★	S-NVD0625100	6.25	60	100	1.6	6	A
★	S-NVD0626100	6.26	60	100	1.6	6	A
★	S-NVD0627100	6.27	60	100	1.6	6	A
★	S-NVD0628100	6.28	60	100	1.6	6	A
★	S-NVD0629100	6.29	60	100	1.6	6	A
●	S-NVD0630100	6.3	60	100	1.6	6	A
★	S-NVD0631100	6.31	60	100	1.6	6	A
★	S-NVD0632100	6.32	60	100	1.6	6	A
★	S-NVD0633100	6.33	60	100	1.6	6	A
★	S-NVD0634100	6.34	60	100	1.6	6	A
★	S-NVD0635100	6.35	60	100	1.6	6	A
★	S-NVD0636100	6.36	60	100	1.6	6	A
★	S-NVD0637100	6.37	60	100	1.6	6	A
★	S-NVD0638100	6.38	60	100	1.6	6	A
★	S-NVD0639100	6.39	60	100	1.6	6	A
●	S-NVD0640100	6.4	60	100	1.6	6	A
★	S-NVD0641100	6.41	60	100	1.6	6	A
★	S-NVD0642100	6.42	60	100	1.6	6	A
★	S-NVD0643100	6.43	60	100	1.6	6	A
★	S-NVD0644100	6.44	60	100	1.6	6	A
★	S-NVD0645100	6.45	60	100	1.6	6	A
★	S-NVD0646100	6.46	60	100	1.6	6	A
★	S-NVD0647100	6.47	60	100	1.6	6	A
★	S-NVD0648100	6.48	60	100	1.6	6	A
★	S-NVD0649100	6.49	60	100	1.6	6	A
●	S-NVD0650100	6.5	60	100	1.6	6	A
★	S-NVD0651100	6.51	60	100	1.6	6	A
★	S-NVD0652100	6.52	60	100	1.6	6	A
★	S-NVD0653100	6.53	60	100	1.6	6	A
★	S-NVD0654100	6.54	60	100	1.7	6	A
★	S-NVD0655100	6.55	60	100	1.7	6	A
★	S-NVD0656100	6.56	60	100	1.7	6	A
★	S-NVD0657100	6.57	60	100	1.7	6	A
★	S-NVD0658100	6.58	60	100	1.7	6	A
★	S-NVD0659100	6.59	60	100	1.7	6	A
●	S-NVD0660100	6.6	60	100	1.7	7	A
★	S-NVD0661100	6.61	60	100	1.7	7	A
★	S-NVD0662100	6.62	60	100	1.7	7	A
★	S-NVD0663100	6.63	60	100	1.7	7	A
★	S-NVD0664100	6.64	60	100	1.7	7	A
★	S-NVD0665100	6.65	60	100	1.7	7	A
★	S-NVD0666100	6.66	60	100	1.7	7	A
★	S-NVD0667100	6.67	60	100	1.7	7	A
★	S-NVD0668100	6.68	60	100	1.7	7	A
★	S-NVD0669100	6.69	60	100	1.7	7	A
●	S-NVD0670100	6.7	60	100	1.7	7	A
★	S-NVD0671100	6.71	60	100	1.7	7	A
★	S-NVD0672100	6.72	60	100	1.7	7	A
★	S-NVD0673100	6.73	60	100	1.7	7	A
★	S-NVD0674100	6.74	60	100	1.7	7	A
★	S-NVD0675100	6.75	60	100	1.7	7	A

●：在庫品 ★：特定代理店在庫 ○：受注生産品

穴あけ加工

Nマドリル
S-NVD

単位：mm

在庫	型番	φ D	φ	L	PL	φ d	TYPE
★	S-NVD0676100	6.76	60	100	1.7	7	A
★	S-NVD0677100	6.77	60	100	1.7	7	A
★	S-NVD0678100	6.78	60	100	1.7	7	A
★	S-NVD0679100	6.79	60	100	1.7	7	A
●	S-NVD0680100	6.8	60	100	1.7	7	A
★	S-NVD0681100	6.81	60	100	1.7	7	A
★	S-NVD0682100	6.82	60	100	1.7	7	A
★	S-NVD0683100	6.83	60	100	1.7	7	A
★	S-NVD0684100	6.84	60	100	1.7	7	A
★	S-NVD0685100	6.85	60	100	1.7	7	A
★	S-NVD0686100	6.86	60	100	1.7	7	A
★	S-NVD0687100	6.87	60	100	1.7	7	A
★	S-NVD0688100	6.88	60	100	1.7	7	A
★	S-NVD0689100	6.89	60	100	1.7	7	A
●	S-NVD0690100	6.9	60	100	1.7	7	A
★	S-NVD0691100	6.91	60	100	1.7	7	A
★	S-NVD0692100	6.92	60	100	1.7	7	A
★	S-NVD0693100	6.93	60	100	1.7	7	A
★	S-NVD0694100	6.94	60	100	1.8	7	A
●	S-NVD0695100	6.95	60	100	1.8	7	A
●	S-NVD0696100	6.96	60	100	1.8	7	A
●	S-NVD0697100	6.97	60	100	1.8	7	A
●	S-NVD0698100	6.98	60	100	1.8	7	A
●	S-NVD0699100	6.99	60	100	1.8	7	A
●	S-NVD0700100	7	60	100	1.8	7	A
●	S-NVD0701100	7.01	60	100	1.8	7	A
●	S-NVD0702100	7.02	60	100	1.8	7	A
●	S-NVD0703100	7.03	60	100	1.8	7	A
●	S-NVD0704100	7.04	60	100	1.8	7	A
●	S-NVD0705100	7.05	60	100	1.8	7	A
★	S-NVD0706100	7.06	60	100	1.8	7	A
★	S-NVD0707100	7.07	60	100	1.8	7	A
★	S-NVD0708100	7.08	60	100	1.8	7	A
★	S-NVD0709100	7.09	60	100	1.8	7	A
●	S-NVD0710100	7.1	60	100	1.8	7	A
★	S-NVD0711100	7.11	60	100	1.8	7	A
★	S-NVD0712100	7.12	60	100	1.8	7	A
★	S-NVD0713100	7.13	60	100	1.8	7	A
★	S-NVD0714100	7.14	60	100	1.8	7	A
★	S-NVD0715100	7.15	60	100	1.8	7	A
★	S-NVD0716100	7.16	60	100	1.8	7	A
★	S-NVD0717100	7.17	60	100	1.8	7	A
★	S-NVD0718100	7.18	60	100	1.8	7	A
★	S-NVD0719100	7.19	60	100	1.8	7	A
●	S-NVD0720100	7.2	60	100	1.8	7	A
★	S-NVD0721100	7.21	60	100	1.8	7	A
★	S-NVD0722100	7.22	60	100	1.8	7	A
★	S-NVD0723100	7.23	60	100	1.8	7	A
★	S-NVD0724100	7.24	60	100	1.8	7	A
★	S-NVD0725100	7.25	60	100	1.8	7	A
★	S-NVD0726100	7.26	60	100	1.8	7	A
★	S-NVD0727100	7.27	60	100	1.8	7	A
★	S-NVD0728100	7.28	60	100	1.8	7	A
★	S-NVD0729100	7.29	60	100	1.8	7	A
●	S-NVD0730100	7.3	60	100	1.8	7	A
★	S-NVD0731100	7.31	60	100	1.8	7	A
★	S-NVD0732100	7.32	60	100	1.8	7	A
★	S-NVD0733100	7.33	60	100	1.8	7	A

穴あけ加工

NVD
S-NVD

●：在庫品 ★：特定代理店在庫 ○：受注生産品

在庫	型番	φ D	ℓ	L	PL	φ d	TYPE
★	S-NVD0734100	7.34	60	100	1.9	7	A
★	S-NVD0735100	7.35	60	100	1.9	7	A
★	S-NVD0736100	7.36	60	100	1.9	7	A
★	S-NVD0737100	7.37	60	100	1.9	7	A
★	S-NVD0738100	7.38	60	100	1.9	7	A
★	S-NVD0739100	7.39	60	100	1.9	7	A
●	S-NVD0740100	7.4	60	100	1.9	7	A
★	S-NVD0741100	7.41	60	100	1.9	7	A
★	S-NVD0742100	7.42	60	100	1.9	7	A
★	S-NVD0743100	7.43	60	100	1.9	7	A
★	S-NVD0744100	7.44	60	100	1.9	7	A
★	S-NVD0745100	7.45	60	100	1.9	7	A
★	S-NVD0746100	7.46	60	100	1.9	7	A
★	S-NVD0747100	7.47	60	100	1.9	7	A
★	S-NVD0748100	7.48	60	100	1.9	7	A
★	S-NVD0749100	7.49	60	100	1.9	7	A
●	S-NVD0750100	7.5	60	100	1.9	7	A
★	S-NVD0751100	7.51	60	100	1.9	7	A
★	S-NVD0752100	7.52	60	100	1.9	7	A
★	S-NVD0753100	7.53	60	100	1.9	7	A
★	S-NVD0754100	7.54	60	100	1.9	7	A
★	S-NVD0755100	7.55	60	100	1.9	7	A
★	S-NVD0756100	7.56	60	100	1.9	7	A
★	S-NVD0757100	7.57	60	100	1.9	7	A
★	S-NVD0758100	7.58	60	100	1.9	7	A
★	S-NVD0759100	7.59	60	100	1.9	7	A
●	S-NVD0760100	7.6	60	100	1.9	8	A
★	S-NVD0761100	7.61	60	100	1.9	8	A
★	S-NVD0762100	7.62	60	100	1.9	8	A
★	S-NVD0763100	7.63	60	100	1.9	8	A
★	S-NVD0764100	7.64	60	100	1.9	8	A
★	S-NVD0765100	7.65	60	100	1.9	8	A
★	S-NVD0766100	7.66	60	100	1.9	8	A
★	S-NVD0767100	7.67	60	100	1.9	8	A
★	S-NVD0768100	7.68	60	100	1.9	8	A
★	S-NVD0769100	7.69	60	100	1.9	8	A
●	S-NVD0770100	7.7	60	100	1.9	8	A
★	S-NVD0771100	7.71	60	100	1.9	8	A
★	S-NVD0772100	7.72	60	100	1.9	8	A
★	S-NVD0773100	7.73	60	100	2	8	A
★	S-NVD0774100	7.74	60	100	2	8	A
★	S-NVD0775100	7.75	60	100	2	8	A
★	S-NVD0776100	7.76	60	100	2	8	A
★	S-NVD0777100	7.77	60	100	2	8	A
★	S-NVD0778100	7.78	60	100	2	8	A
★	S-NVD0779100	7.79	60	100	2	8	A
●	S-NVD0780100	7.8	60	100	2	8	A
★	S-NVD0781100	7.81	60	100	2	8	A
★	S-NVD0782100	7.82	60	100	2	8	A
★	S-NVD0783100	7.83	60	100	2	8	A
★	S-NVD0784100	7.84	60	100	2	8	A
★	S-NVD0785100	7.85	60	100	2	8	A
★	S-NVD0786100	7.86	60	100	2	8	A
★	S-NVD0787100	7.87	60	100	2	8	A
★	S-NVD0788100	7.88	60	100	2	8	A
★	S-NVD0789100	7.89	60	100	2	8	A
●	S-NVD0790100	7.9	60	100	2	8	A
★	S-NVD0791100	7.91	60	100	2	8	A

● : 在庫品 ★ : 特定代理店在庫 ○ : 受注生産品

単位：mm

在庫	型番	φ D	φ	L	PL	φ d	TYPE
★	S-NVD0792100	7.92	60	100	2	8	A
★	S-NVD0793100	7.93	60	100	2	8	A
★	S-NVD0794100	7.94	60	100	2	8	A
●	S-NVD0795100	7.95	60	100	2	8	A
●	S-NVD0796100	7.96	60	100	2	8	A
●	S-NVD0797100	7.97	60	100	2	8	A
●	S-NVD0798100	7.98	60	100	2	8	A
●	S-NVD0799100	7.99	60	100	2	8	A
●	S-NVD0800100	8	60	100	2	8	A
●	S-NVD0801100	8.01	60	100	2	8	A
●	S-NVD0802100	8.02	60	100	2	8	A
●	S-NVD0803100	8.03	60	100	2	8	A
●	S-NVD0804100	8.04	60	100	2	8	A
●	S-NVD0805100	8.05	60	100	2	8	A
★	S-NVD0806100	8.06	60	100	2	8	A
★	S-NVD0807100	8.07	60	100	2	8	A
★	S-NVD0808100	8.08	60	100	2	8	A
★	S-NVD0809100	8.09	60	100	2	8	A
●	S-NVD0810100	8.1	60	100	2	8	A
★	S-NVD0811100	8.11	60	100	2	8	A
★	S-NVD0812100	8.12	60	100	2	8	A
★	S-NVD0813100	8.13	60	100	2.1	8	A
★	S-NVD0814100	8.14	60	100	2.1	8	A
★	S-NVD0815100	8.15	60	100	2.1	8	A
★	S-NVD0816100	8.16	60	100	2.1	8	A
★	S-NVD0817100	8.17	60	100	2.1	8	A
★	S-NVD0818100	8.18	60	100	2.1	8	A
★	S-NVD0819100	8.19	60	100	2.1	8	A
●	S-NVD0820100	8.2	60	100	2.1	8	A
★	S-NVD0821100	8.21	60	100	2.1	8	A
★	S-NVD0822100	8.22	60	100	2.1	8	A
★	S-NVD0823100	8.23	60	100	2.1	8	A
★	S-NVD0824100	8.24	60	100	2.1	8	A
★	S-NVD0825100	8.25	60	100	2.1	8	A
★	S-NVD0826100	8.26	60	100	2.1	8	A
★	S-NVD0827100	8.27	60	100	2.1	8	A
★	S-NVD0828100	8.28	60	100	2.1	8	A
★	S-NVD0829100	8.29	60	100	2.1	8	A
●	S-NVD0830100	8.3	60	100	2.1	8	A
★	S-NVD0831100	8.31	60	100	2.1	8	A
★	S-NVD0832100	8.32	60	100	2.1	8	A
★	S-NVD0833100	8.33	60	100	2.1	8	A
★	S-NVD0834100	8.34	60	100	2.1	8	A
★	S-NVD0835100	8.35	60	100	2.1	8	A
★	S-NVD0836100	8.36	60	100	2.1	8	A
★	S-NVD0837100	8.37	60	100	2.1	8	A
★	S-NVD0838100	8.38	60	100	2.1	8	A
★	S-NVD0839100	8.39	60	100	2.1	8	A
●	S-NVD0840100	8.4	60	100	2.1	8	A
★	S-NVD0841100	8.41	60	100	2.1	8	A
★	S-NVD0842100	8.42	60	100	2.1	8	A
★	S-NVD0843100	8.43	60	100	2.1	8	A
★	S-NVD0844100	8.44	60	100	2.1	8	A
★	S-NVD0845100	8.45	60	100	2.1	8	A
★	S-NVD0846100	8.46	60	100	2.1	8	A
★	S-NVD0847100	8.47	60	100	2.1	8	A
★	S-NVD0848100	8.48	60	100	2.1	8	A
★	S-NVD0849100	8.49	60	100	2.1	8	A

●：在庫品 ★：特定代理店在庫 ○：受注生産品

在庫	型番	φ D	ℓ	L	PL	φ d	TYPE
●	S-NVD0850100	8.5	60	100	2.1	8	A
★	S-NVD0851100	8.51	60	100	2.1	8	A
★	S-NVD0852100	8.52	60	100	2.1	8	A
★	S-NVD0853100	8.53	60	100	2.2	8	A
★	S-NVD0854100	8.54	60	100	2.2	8	A
★	S-NVD0855100	8.55	60	100	2.2	8	A
★	S-NVD0856100	8.56	60	100	2.2	8	A
★	S-NVD0857100	8.57	60	100	2.2	8	A
★	S-NVD0858100	8.58	60	100	2.2	8	A
★	S-NVD0859100	8.59	60	100	2.2	8	A
●	S-NVD0860115	8.6	75	115	2.2	9	A
★	S-NVD0861115	8.61	75	115	2.2	9	A
★	S-NVD0862115	8.62	75	115	2.2	9	A
★	S-NVD0863115	8.63	75	115	2.2	9	A
★	S-NVD0864115	8.64	75	115	2.2	9	A
★	S-NVD0865115	8.65	75	115	2.2	9	A
★	S-NVD0866115	8.66	75	115	2.2	9	A
★	S-NVD0867115	8.67	75	115	2.2	9	A
★	S-NVD0868115	8.68	75	115	2.2	9	A
★	S-NVD0869115	8.69	75	115	2.2	9	A
●	S-NVD0870115	8.7	75	115	2.2	9	A
★	S-NVD0871115	8.71	75	115	2.2	9	A
★	S-NVD0872115	8.72	75	115	2.2	9	A
★	S-NVD0873115	8.73	75	115	2.2	9	A
★	S-NVD0874115	8.74	75	115	2.2	9	A
★	S-NVD0875115	8.75	75	115	2.2	9	A
★	S-NVD0876115	8.76	75	115	2.2	9	A
★	S-NVD0877115	8.77	75	115	2.2	9	A
★	S-NVD0878115	8.78	75	115	2.2	9	A
★	S-NVD0879115	8.79	75	115	2.2	9	A
●	S-NVD0880115	8.8	75	115	2.2	9	A
★	S-NVD0881115	8.81	75	115	2.2	9	A
★	S-NVD0882115	8.82	75	115	2.2	9	A
★	S-NVD0883115	8.83	75	115	2.2	9	A
★	S-NVD0884115	8.84	75	115	2.2	9	A
★	S-NVD0885115	8.85	75	115	2.2	9	A
★	S-NVD0886115	8.86	75	115	2.2	9	A
★	S-NVD0887115	8.87	75	115	2.2	9	A
★	S-NVD0888115	8.88	75	115	2.2	9	A
★	S-NVD0889115	8.89	75	115	2.2	9	A
●	S-NVD0890115	8.9	75	115	2.2	9	A
★	S-NVD0891115	8.91	75	115	2.2	9	A
★	S-NVD0892115	8.92	75	115	2.2	9	A
★	S-NVD0893115	8.93	75	115	2.3	9	A
★	S-NVD0894115	8.94	75	115	2.3	9	A
●	S-NVD0895115	8.95	75	115	2.3	9	A
●	S-NVD0896115	8.96	75	115	2.3	9	A
●	S-NVD0897115	8.97	75	115	2.3	9	A
●	S-NVD0898115	8.98	75	115	2.3	9	A
●	S-NVD0899115	8.99	75	115	2.3	9	A
●	S-NVD0900115	9	75	115	2.3	9	A
●	S-NVD0901115	9.01	75	115	2.3	9	A
●	S-NVD0902115	9.02	75	115	2.3	9	A
●	S-NVD0903115	9.03	75	115	2.3	9	A
●	S-NVD0904115	9.04	75	115	2.3	9	A
●	S-NVD0905115	9.05	75	115	2.3	9	A
★	S-NVD0906115	9.06	75	115	2.3	9	A
★	S-NVD0907115	9.07	75	115	2.3	9	A

● : 在庫品 ★ : 特定代理店在庫 ○ : 受注生産品

穴あけ加工

Nマドリル
S-NVD

単位：mm

在庫	型番	φ D	φ	L	PL	φ d	TYPE
★	S-NVD0908115	9.08	75	115	2.3	9	A
★	S-NVD0909115	9.09	75	115	2.3	9	A
●	S-NVD0910115	9.1	75	115	2.3	9	A
★	S-NVD0911115	9.11	75	115	2.3	9	A
★	S-NVD0912115	9.12	75	115	2.3	9	A
★	S-NVD0913115	9.13	75	115	2.3	9	A
★	S-NVD0914115	9.14	75	115	2.3	9	A
★	S-NVD0915115	9.15	75	115	2.3	9	A
★	S-NVD0916115	9.16	75	115	2.3	9	A
★	S-NVD0917115	9.17	75	115	2.3	9	A
★	S-NVD0918115	9.18	75	115	2.3	9	A
★	S-NVD0919115	9.19	75	115	2.3	9	A
●	S-NVD0920115	9.2	75	115	2.3	9	A
★	S-NVD0921115	9.21	75	115	2.3	9	A
★	S-NVD0922115	9.22	75	115	2.3	9	A
★	S-NVD0923115	9.23	75	115	2.3	9	A
★	S-NVD0924115	9.24	75	115	2.3	9	A
★	S-NVD0925115	9.25	75	115	2.3	9	A
★	S-NVD0926115	9.26	75	115	2.3	9	A
★	S-NVD0927115	9.27	75	115	2.3	9	A
★	S-NVD0928115	9.28	75	115	2.3	9	A
★	S-NVD0929115	9.29	75	115	2.3	9	A
●	S-NVD0930115	9.3	75	115	2.3	9	A
★	S-NVD0931115	9.31	75	115	2.3	9	A
★	S-NVD0932115	9.32	75	115	2.4	9	A
★	S-NVD0933115	9.33	75	115	2.4	9	A
★	S-NVD0934115	9.34	75	115	2.4	9	A
★	S-NVD0935115	9.35	75	115	2.4	9	A
★	S-NVD0936115	9.36	75	115	2.4	9	A
★	S-NVD0937115	9.37	75	115	2.4	9	A
★	S-NVD0938115	9.38	75	115	2.4	9	A
★	S-NVD0939115	9.39	75	115	2.4	9	A
●	S-NVD0940115	9.4	75	115	2.4	9	A
★	S-NVD0941115	9.41	75	115	2.4	9	A
★	S-NVD0942115	9.42	75	115	2.4	9	A
★	S-NVD0943115	9.43	75	115	2.4	9	A
★	S-NVD0944115	9.44	75	115	2.4	9	A
★	S-NVD0945115	9.45	75	115	2.4	9	A
★	S-NVD0946115	9.46	75	115	2.4	9	A
★	S-NVD0947115	9.47	75	115	2.4	9	A
★	S-NVD0948115	9.48	75	115	2.4	9	A
★	S-NVD0949115	9.49	75	115	2.4	9	A
●	S-NVD0950115	9.5	75	115	2.4	9	A
★	S-NVD0951115	9.51	75	115	2.4	9	A
★	S-NVD0952115	9.52	75	115	2.4	9	A
★	S-NVD0953115	9.53	75	115	2.4	9	A
★	S-NVD0954115	9.54	75	115	2.4	9	A
★	S-NVD0955115	9.55	75	115	2.4	9	A
★	S-NVD0956115	9.56	75	115	2.4	9	A
★	S-NVD0957115	9.57	75	115	2.4	9	A
★	S-NVD0958115	9.58	75	115	2.4	9	A
★	S-NVD0959115	9.59	75	115	2.4	9	A
●	S-NVD0960115	9.6	75	115	2.4	10	A
★	S-NVD0961115	9.61	75	115	2.4	10	A
★	S-NVD0962115	9.62	75	115	2.4	10	A
★	S-NVD0963115	9.63	75	115	2.4	10	A
★	S-NVD0964115	9.64	75	115	2.4	10	A
★	S-NVD0965115	9.65	75	115	2.4	10	A

穴あけ加工

NVD
S-NVD

●：在庫品 ★：特定代理店在庫 ○：受注生産品

在庫	型番	φ D	ℓ	L	PL	φ d	TYPE
★	S-NVD0966115	9.66	75	115	2.4	10	A
★	S-NVD0967115	9.67	75	115	2.4	10	A
★	S-NVD0968115	9.68	75	115	2.4	10	A
★	S-NVD0969115	9.69	75	115	2.4	10	A
●	S-NVD0970115	9.7	75	115	2.4	10	A
★	S-NVD0971115	9.71	75	115	2.4	10	A
★	S-NVD0972115	9.72	75	115	2.5	10	A
★	S-NVD0973115	9.73	75	115	2.5	10	A
★	S-NVD0974115	9.74	75	115	2.5	10	A
★	S-NVD0975115	9.75	75	115	2.5	10	A
★	S-NVD0976115	9.76	75	115	2.5	10	A
★	S-NVD0977115	9.77	75	115	2.5	10	A
★	S-NVD0978115	9.78	75	115	2.5	10	A
★	S-NVD0979115	9.79	75	115	2.5	10	A
●	S-NVD0980115	9.8	75	115	2.5	10	A
★	S-NVD0981115	9.81	75	115	2.5	10	A
★	S-NVD0982115	9.82	75	115	2.5	10	A
★	S-NVD0983115	9.83	75	115	2.5	10	A
★	S-NVD0984115	9.84	75	115	2.5	10	A
★	S-NVD0985115	9.85	75	115	2.5	10	A
★	S-NVD0986115	9.86	75	115	2.5	10	A
★	S-NVD0987115	9.87	75	115	2.5	10	A
★	S-NVD0988115	9.88	75	115	2.5	10	A
★	S-NVD0989115	9.89	75	115	2.5	10	A
●	S-NVD0990115	9.9	75	115	2.5	10	A
★	S-NVD0991115	9.91	75	115	2.5	10	A
★	S-NVD0992115	9.92	75	115	2.5	10	A
★	S-NVD0993115	9.93	75	115	2.5	10	A
★	S-NVD0994115	9.94	75	115	2.5	10	A
●	S-NVD0995115	9.95	75	115	2.5	10	A
●	S-NVD0996115	9.96	75	115	2.5	10	A
●	S-NVD0997115	9.97	75	115	2.5	10	A
●	S-NVD0998115	9.98	75	115	2.5	10	A
●	S-NVD0999115	9.99	75	115	2.5	10	A
●	S-NVD1000115	10	75	115	2.5	10	A
●	S-NVD1001115	10.01	75	115	2.5	10	A
●	S-NVD1002115	10.02	75	115	2.5	10	A
●	S-NVD1003115	10.03	75	115	2.5	10	A
●	S-NVD1004115	10.04	75	115	2.5	10	A
●	S-NVD1005115	10.05	75	115	2.5	10	A
●	S-NVD1010115	10.1	75	115	2.5	10	A
●	S-NVD1020115	10.2	75	115	2.6	10	A
●	S-NVD1030115	10.3	75	115	2.6	10	A
●	S-NVD1040115	10.4	75	115	2.6	10	A
●	S-NVD1050115	10.5	75	115	2.6	10	A
●	S-NVD1060115	10.6	75	115	2.7	11	A
●	S-NVD1070115	10.7	75	115	2.7	11	A
●	S-NVD1080115	10.8	75	115	2.7	11	A
●	S-NVD1090115	10.9	75	115	2.7	11	A
●	S-NVD1095115	10.95	75	115	2.8	11	A
●	S-NVD1096115	10.96	75	115	2.8	11	A
●	S-NVD1097115	10.97	75	115	2.8	11	A
●	S-NVD1098115	10.98	75	115	2.8	11	A
●	S-NVD1099115	10.99	75	115	2.8	11	A
●	S-NVD1100115	11	75	115	2.8	11	A
●	S-NVD1101115	11.01	75	115	2.8	11	A
●	S-NVD1102115	11.02	75	115	2.8	11	A
●	S-NVD1103115	11.03	75	115	2.8	11	A

● : 在庫品 ★ : 特定代理店在庫 ○ : 受注生産品

穴あけ加工

Nマドリル
S-NVD

単位：mm

在庫	型番	φ D	φ	L	PL	φ d	TYPE
●	S-NVD1104115	11.04	75	115	2.8	11	A
●	S-NVD1105115	11.05	75	115	2.8	11	A
●	S-NVD1110115	11.1	75	115	2.8	11	A
●	S-NVD1120115	11.2	75	115	2.8	11	A
●	S-NVD1130115	11.3	75	115	2.8	11	A
●	S-NVD1140115	11.4	75	115	2.9	11	A
●	S-NVD1150115	11.5	75	115	2.9	11	A
●	S-NVD1160140	11.6	90	140	2.9	12	A
●	S-NVD1170140	11.7	90	140	2.9	12	A
●	S-NVD1180140	11.8	90	140	3	12	A
●	S-NVD1190140	11.9	90	140	3	12	A
●	S-NVD1195140	11.95	90	140	3	12	A
●	S-NVD1196140	11.96	90	140	3	12	A
●	S-NVD1197140	11.97	90	140	3	12	A
●	S-NVD1198140	11.98	90	140	3	12	A
●	S-NVD1199140	11.99	90	140	3	12	A
●	S-NVD1200140	12	90	140	3	12	A
●	S-NVD1201140	12.01	90	140	3	12	A
●	S-NVD1202140	12.02	90	140	3	12	A
●	S-NVD1203140	12.03	90	140	3	12	A
●	S-NVD1204140	12.04	90	140	3	12	A
●	S-NVD1205140	12.05	90	140	3	12	A
●	S-NVD1210140	12.1	90	140	3.1	12	A
●	S-NVD1220140	12.2	90	140	3.1	12	A
●	S-NVD1230140	12.3	90	140	3.1	12	A
●	S-NVD1240140	12.4	90	140	3.1	12	A
●	S-NVD1250140	12.5	90	140	3.2	12	A
●	S-NVD1260140	12.6	90	140	3.2	13	A
●	S-NVD1270140	12.7	90	140	3.2	13	A
●	S-NVD1280140	12.8	90	140	3.2	13	A
●	S-NVD1290140	12.9	90	140	3.3	13	A
●	S-NVD1300140	13	90	140	3.3	13	A
●	S-NVD1310150	13.1	90	150	3.3	14	A
●	S-NVD1320150	13.2	90	150	3.3	14	A
●	S-NVD1330150	13.3	90	150	3.4	14	A
●	S-NVD1340150	13.4	90	150	3.4	14	A
●	S-NVD1350150	13.5	90	150	3.4	14	A
●	S-NVD1360150	13.6	90	150	3.4	14	A
●	S-NVD1370150	13.7	90	150	3.5	14	A
●	S-NVD1380150	13.8	90	150	3.5	14	A
●	S-NVD1390150	13.9	90	150	3.5	14	A
●	S-NVD1400150	14	90	150	3.5	14	A
●	S-NVD1410150	14.1	90	150	3.6	16	A
●	S-NVD1420150	14.2	90	150	3.6	16	A
●	S-NVD1430150	14.3	90	150	3.6	16	A
●	S-NVD1440150	14.4	90	150	3.6	16	A
●	S-NVD1450150	14.5	90	150	3.7	16	A
●	S-NVD1460150	14.6	90	150	3.7	16	A
●	S-NVD1470150	14.7	90	150	3.7	16	A
●	S-NVD1480150	14.8	90	150	3.7	16	A
●	S-NVD1490150	14.9	90	150	3.8	16	A
●	S-NVD1500150	15	90	150	3.8	16	A
●	S-NVD1510150	15.1	90	150	3.8	16	A
●	S-NVD1520150	15.2	90	150	3.8	16	A
●	S-NVD1530150	15.3	90	150	3.9	16	A
●	S-NVD1540150	15.4	90	150	3.9	16	A
●	S-NVD1550150	15.5	90	150	3.9	16	A
●	S-NVD1560150	15.6	90	150	3.9	16	A

穴あけ加工

NVD
S-NVD

●：在庫品 ★：特定代理店在庫 ○：受注生産品

単位 : mm

在庫	型番	φ D	φ	L	PL	φ d	TYPE
●	S-NVD1570150	15.7	90	150	4	16	A
●	S-NVD1580150	15.8	90	150	4	16	A
●	S-NVD1590150	15.9	90	150	4	16	A
●	S-NVD1600150	16	90	150	4	16	A
★	S-NVD1700215	17	115	215	4.3	20	B
★	S-NVD1800225	18	125	225	4.5	20	B
★	S-NVD1900225	19	125	225	4.8	20	B
★	S-NVD2000245	20	125	245	5	20	B
★	S-NVD2100255	21	135	255	5.3	25	B
★	S-NVD2200255	22	135	255	5.5	25	B
★	S-NVD2300265	23	145	265	5.8	25	B
★	S-NVD2400265	24	145	265	6	25	B
★	S-NVD2500270	25	145	270	6.3	25	B
★	S-NVD2600280	26	155	280	6.5	32	B
★	S-NVD2700280	27	155	280	6.8	32	B
★	S-NVD2800280	28	155	280	7.1	32	B
★	S-NVD2900280	29	155	280	7.3	32	B
★	S-NVD3000280	30	155	280	7.6	32	B

穴あけ加工

NVD
S-NVD

● : 在庫品 ★ : 特定代理店在庫 ○ : 受注生産品

NVDドリル(ハーフサイズ)

加工穴精度: IT7級

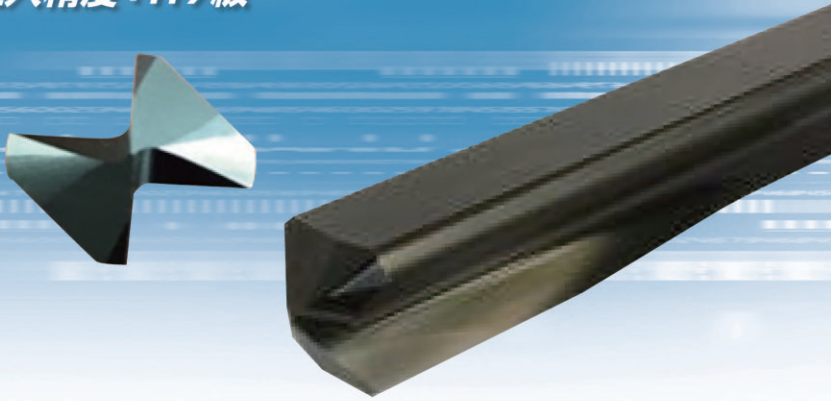

φ1~16あり
0.01mmトビ
新サイズ追加

特長

- ①下穴・センターモミ不要、一発加工で鏡面仕上げ可能
- ②φ1~φ16まで0.1mmトビの豊富なラインアップ
(φ2~0.01mmトビサイズも有り)

4点ガイドパット
セルフガイド
面粗度・面積度UP

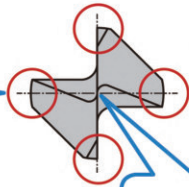

切れ味に優れる

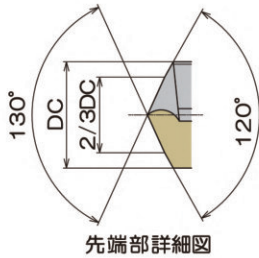
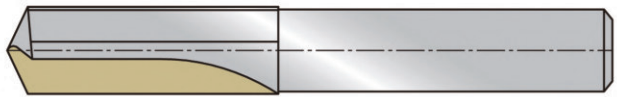

加工事例

貫通穴加工

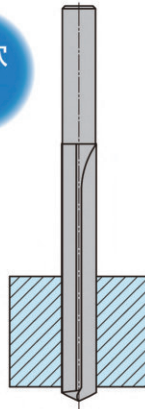

止り穴加工

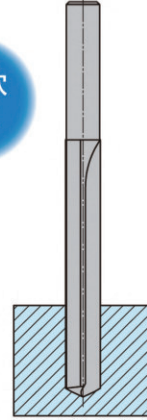

クロス穴加工

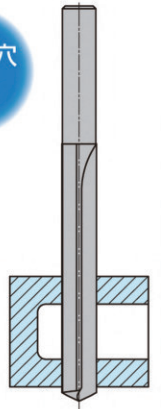

形状概要

ニチアロイ独自刃型NVDドリル

- ①ドリル中心部までシャープな切れ味を有する
- ②リップ部は強度を重点に設計
- ③ガイドパット側のマージン幅が広い設定

S-NVD(従来品)



S-NVDH

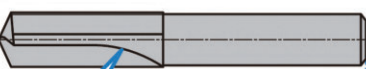

溝長50%短かく設定!
(φ2.5までは20%)

全長30%コンパクトに!

工具突出し量低減

たわみ量低減

工具破損の低減
真直性の向上

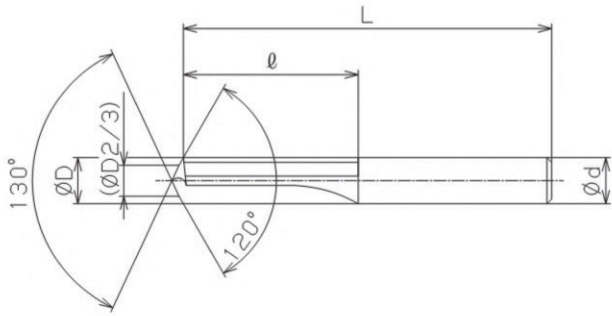

炭素鋼・合金鋼		アルミニウム合金	◎	銅合金	△
鑄鉄	◎	樹脂		真鍮	△
ダクタイル鑄鉄	○	ステンレス			

推奨条件

被削材	切削速度 V (m/min)	送り f (mm/rev)
アルミ	50 ~ 150	0.05 ~ 0.15
鑄鉄	20 ~ 70	0.05 ~ 0.1

単位 : mm

φD (0.1とび)	φD公差	ℓ	L	φd	φd公差
1~1.9	+0.003/0	8	30	φD=φd	+0.003/0
2~2.5	+0.003/0	10	40	φD=φd	+0.003/0
2.6~2.9	+0.003/0	10	50	φD=φd	+0.003/0
3~3.5	+0.007/+0.003	25	55	3	0/-0.010
3.6~4	+0.007/+0.003	25	55	4	0/-0.012
4.1~4.5	+0.008/+0.004	25	55	4	0/-0.012
4.6~5.5	+0.008/+0.004	25	55	5	0/-0.012
5.6~6	+0.008/+0.004	30	70	6	0/-0.012
6.1~6.5	+0.010/+0.005	30	70	6	0/-0.012
6.6~7.5	+0.010/+0.005	30	70	7	0/-0.015
7.6~8	+0.010/+0.005	30	70	8	0/-0.015
8.1~8.5	+0.010/+0.005	30	80	8	0/-0.015
8.6~9.5	+0.010/+0.005	38	80	9	0/-0.015
9.6~10	+0.010/+0.005	38	80	10	0/-0.015
10.1~10.5	+0.012/+0.006	38	80	10	0/-0.015
10.6~10.9	+0.012/+0.006	38	80	11	0/-0.015
11~11.5	+0.012/+0.006	38	80	11	0/-0.018
11.6~12.5	+0.012/+0.006	45	95	12	0/-0.018
12.6~13	+0.012/+0.006	45	95	13	0/-0.018
13.1~13.4	+0.012/+0.006	45	100	13	0/-0.018
13.5~14	+0.012/+0.006	45	100	14	0/-0.018
14.1~16	+0.012/+0.006	45	100	16	0/-0.018

φD (0.01とび)	φD (0.05とび)	φD公差	ℓ	L	φd	φd公差
1.95~1.99		+0.003/0	8	30	φD=φd	+0.003/0
2.01~2.05		+0.003/0	10	40	φD=φd	+0.003/0
2.45~2.55		+0.003/0	10	40	φD=φd	+0.003/0
2.95~2.98		+0.003/0	25	55	φD=φd	+0.003/0
2.99~3.05		+0.007/+0.003	25	55	3	0/-0.010
3.06~3.59		+0.005/0	25	55	3	0/-0.010
3.61~3.94		+0.005/0	25	55	4	0/-0.012
3.95~4.05		+0.007/+0.003	25	55	4	0/-0.012
4.06~4.59		+0.005/0	25	55	4	0/-0.012
4.61~4.94		+0.005/0	25	55	5	0/-0.012
4.95~5.05		+0.008/+0.004	25	55	5	0/-0.012
5.06~5.09		+0.005/0	25	55	5	0/-0.012
	5.15~5.35	+0.005/0	25	55	5	0/-0.012
5.41~5.59		+0.005/0	25	55	5	0/-0.012
	5.65~5.85	+0.005/0	30	70	6	0/-0.012
5.91~5.94		+0.005/0	30	70	6	0/-0.012
5.95~6.05		+0.008/+0.004	30	70	6	0/-0.012
6.06~6.09		+0.005/0	30	70	6	0/-0.012
	6.15~6.35	+0.005/0	30	70	6	0/-0.012
6.41~6.59		+0.005/0	30	70	6	0/-0.012
	6.65~6.85	+0.005/0	30	70	7	0/-0.015
6.91~6.94		+0.005/0	30	70	7	0/-0.015
6.95~7.05		+0.010/+0.005	30	70	7	0/-0.015
7.06~7.09		+0.005/0	30	70	7	0/-0.015
	7.15~7.35	+0.005/0	30	70	7	0/-0.015
7.41~7.59		+0.005/0	30	70	7	0/-0.015
	7.65~7.85	+0.005/0	30	70	8	0/-0.015
7.91~7.94		+0.005/0	30	70	8	0/-0.015
7.95~8.05		+0.010/+0.005	30	70	8	0/-0.015
8.06~8.09		+0.005/0	30	70	8	0/-0.015
	8.15~8.35	+0.005/0	30	80	8	0/-0.015
8.41~8.59		+0.005/0	30	80	8	0/-0.015
	8.65~8.85	+0.005/0	38	80	9	0/-0.015
8.91~8.94		+0.005/0	38	80	9	0/-0.015
8.95~9.05		+0.010/+0.005	38	80	9	0/-0.015
9.95~10.05		+0.010/+0.005	38	80	10	0/-0.015
10.95~11.05		+0.012/+0.006	38	80	11	0/-0.018
11.95~12.05		+0.012/+0.006	45	95	12	0/-0.018



日本超硬株式会社
NIPPON CHOKO CO.,LTD.

本社・工場 〒448-0847 愛知県刈谷市宝町6丁目31番地
TEL(0566)21-2000(代)FAX(0566)21-6342
TEL(0566)27-3801(直)
E-mail : eigyo@nichialloy.co.jp
URL : www.nichialloy.co.jp/

岐阜工場 〒509-5312 岐阜県土岐市鶴里町柿野字梅之木690
TEL(0572)52-2175(代)FAX(0572)52-2785

関東営業所 〒373-0813 群馬県太田市内ヶ島町866-14 メゾン・ド・セイリング101号
TEL(0276)56-9678(代)FAX(0276)56-9679

関西営業所 〒577-0012 大阪府東大阪市長田東4丁目2番32号(大真ビル9F)
TEL(06)6748-7501(代)FAX(06)6748-7502

KS-NVD

- ▶ 高能率と高精度を両立したドリル
- ▶ 加工精度 H7公差
- ▶ 従来のドリルに対して加工時間1/3 ~ 1/5に短縮

高能率NVドリル

炭素鋼・合金鋼		アルミニウム合金	◎	銅合金	
鋳鉄		樹脂		真鍮	
ダクタイル鋳鉄		ステンレス			

φD公差		
φ5~φ6	φ6.5~φ10	φ10.5~φ16
+0.008	+0.010	+0.012
+0.004	+0.005	+0.006

φd公差		
φ5~φ6	φ7~φ10	φ11~φ16
0	0	0
-0.008	-0.009	-0.011

推奨条件		
被削材	切削速度 V (m/min)	送り f (mm/rev)
アルミ	150 ~ 200	0.3 ~ 0.7

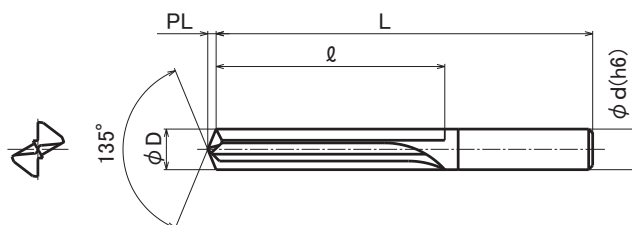

ソリッドストレートシャンク 材種 K10

単位：mm

在庫	型番	φD	ℓ	L	PL	φd
★	KS-NVD050080	5	50	80	1.0	5
★	KS-NVD055080	5.5	50	80	1.1	5
★	KS-NVD060100	6	60	100	1.2	6
★	KS-NVD065100	6.5	60	100	1.4	6
★	KS-NVD070100	7	60	100	1.5	7
★	KS-NVD075100	7.5	60	100	1.6	7
★	KS-NVD080100	8	60	100	1.7	8
★	KS-NVD085100	8.5	60	100	1.8	8
★	KS-NVD090115	9	75	115	1.9	9
★	KS-NVD095115	9.5	75	115	2	9
★	KS-NVD100115	10	75	115	2.1	10
★	KS-NVD105115	10.5	75	115	2.2	10
★	KS-NVD110115	11	75	115	2.3	11
★	KS-NVD120140	12	90	140	2.5	12
★	KS-NVD130140	13	90	140	2.7	13
★	KS-NVD140140	14	90	140	2.9	14
★	KS-NVD150140	15	90	140	3.1	16
★	KS-NVD160140	16	90	140	3.3	16

IS-NVD

- ▶ 鑄抜穴に対して1パス仕上加工を実現
- ▶ 加工精度 H7公差
- ▶ 従来のドリルに対して穴位置精度5倍向上
- ▶ 貫通穴加工時のバリ生成小

鑄抜穴用NVドリル

炭素鋼・合金鋼	
鑄鉄	
ダクタイル鑄鉄	

アルミニウム合金	◎
樹脂	
ステンレス	

銅合金	
真鍮	

φ D公差		
φ 6	φ 6.5~φ 10	φ 11~φ 16
+0.008	+0.010	+0.012
+0.004	+0.005	+0.006

φ d公差		
φ 6	φ 7~φ 10	φ 11~φ 16
0	0	0
-0.008	-0.009	-0.011

推奨条件		
被削材	切削速度 V (m/min)	送り f (mm/rev)
アルミ	100~200	0.1~0.3

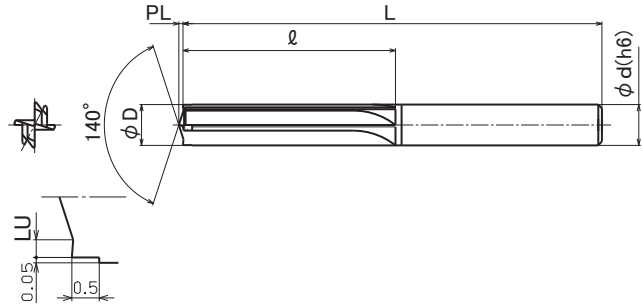

ソリッドストレートシャンク 材種 K10

単位：mm

在庫	型番	φ D	ℓ	L	LU	PL	φ d
★	IS-NVD060100	6	40	100	0.85	0.7	6
★	IS-NVD065100	6.5	40	100	0.9	0.8	6
★	IS-NVD070100	7	50	100	1	0.8	7
★	IS-NVD075100	7.5	50	100	1.05	0.9	7
★	IS-NVD080100	8	50	100	1.15	0.9	8
★	IS-NVD085100	8.5	50	100	1.2	1	8
★	IS-NVD090115	9	60	115	1.3	1	9
★	IS-NVD095115	9.5	60	115	1.4	1.1	9
★	IS-NVD100115	10	60	115	1.45	1.2	10
★	IS-NVD110115	11	60	115	1.6	1.3	11
★	IS-NVD120140	12	75	140	1.75	1.4	12
★	IS-NVD130140	13	75	140	1.9	1.5	13
★	IS-NVD140140	14	75	140	2.05	1.6	14
★	IS-NVD150140	15	80	140	2.2	1.7	16
★	IS-NVD160140	16	80	140	2.35	1.8	16

ND-S-NVD

Nダイヤモンドドリル

- ▶ 切削速度 100 ~ 300m/min 高速加工可能
- ▶ 高精度仕上げ面粗度 Ra0.4 以下
- ▶ 加工精度 H7 公差
- ▶ 超硬工具の 10 ~ 100 倍の高寿命
- ▶ ハイスリコン合金加工に最適

炭素鋼・合金鋼	アルミニウム合金	銅合金
鋳鉄	樹脂	真鍮
ダクタイル鋳鉄	ステンレス	

φ 5 ~ φ 6.5	φ 7 ~ φ 10	φ 10.5 ~ φ 18.5	φ 19 ~ φ 20
+0.008 +0.005	+0.010 +0.007	+0.013 +0.010	+0.016 +0.013

φ 6	φ 8 ~ φ 10	φ 12 ~ φ 18	φ 20
0 -0.012	0 -0.015	0 -0.018	0 -0.021

被削材	切削速度 V (m/min)	送り f (mm/rev)
アルミ	100 ~ 300	0.1 ~ 0.3

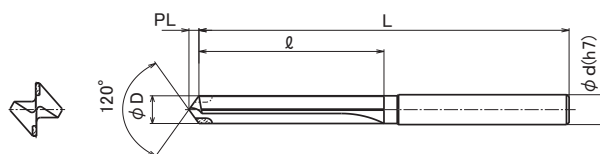

ソリッドストレートシャンク 材種 DIA

単位：mm

在庫	型番	φ D	ℓ	L	PL	φ d
★	ND-S-NVD050070	5	30	70	1.4	6
○	ND-S-NVD055070	5.5	30	70	1.6	6
★	ND-S-NVD060070	6	30	70	1.7	6
○	ND-S-NVD065070	6.5	30	70	1.9	6
★	ND-S-NVD070100	7	40	100	2.0	8
○	ND-S-NVD075100	7.5	40	100	2.2	8
★	ND-S-NVD080100	8	40	100	2.3	8
○	ND-S-NVD085100	8.5	40	100	2.5	8
★	ND-S-NVD090115	9	55	115	2.6	10
○	ND-S-NVD095115	9.5	55	115	2.7	10
★	ND-S-NVD100115	10	55	115	2.9	10
○	ND-S-NVD105115	10.5	55	115	3.0	10
★	ND-S-NVD110140	11	70	140	3.2	12
○	ND-S-NVD115140	11.5	70	140	3.3	12
★	ND-S-NVD120140	12	70	140	3.5	12
○	ND-S-NVD125140	12.5	70	140	3.6	12
★	ND-S-NVD130140	13	70	140	3.8	14
○	ND-S-NVD135140	13.5	70	140	3.9	14
★	ND-S-NVD140140	14	70	140	4.0	14
○	ND-S-NVD145140	14.5	70	140	4.2	14
★	ND-S-NVD150150	15	80	150	4.3	16
○	ND-S-NVD155150	15.5	80	150	4.5	16
★	ND-S-NVD160150	16	80	150	4.6	16

●：在庫品 ★：特定代理店在庫 ○：受注生産品

単位：mm

在庫	型番	φ D	ℓ	L	PL	φ d
○	ND-S-NVD165150	16.5	80	150	4.8	16
★	ND-S-NVD170160	17	90	160	4.9	18
○	ND-S-NVD175160	17.5	90	160	5.1	18
★	ND-S-NVD180160	18	90	160	5.2	18
○	ND-S-NVD185160	18.5	90	160	5.3	18
★	ND-S-NVD190170	19	100	170	5.5	20
○	ND-S-NVD195170	19.5	100	170	5.6	20
★	ND-S-NVD200170	20	100	170	5.8	20

穴あけ加工

ND-S-NVD
Nダイヤル
Nドリル